

J. Devaney

LA-UR 78-130

C.1

**TITLE:** RECENT PROGRESS IN INERTIAL CONFINEMENT FUSION RESEARCH AT THE LOS ALAMOS SCIENTIFIC LABORATORY

**DO NOT CIRCULATE**  
Retention Copy

**AUTHOR(S):** Roger B. Perkins

**SUBMITTED TO:** U.S./IAEA Conference on Inertial Confinement Fusion, San Francisco, CA  
February 1-3, 1978

By acceptance of this article for publication, the publisher recognizes the Government's (license) rights in any copyright and the Government and its authorized representatives have unrestricted right to reproduce in whole or in part said article under any copyright secured by the publisher.

The Los Alamos Scientific Laboratory requests that the publisher identify this article as work performed under the auspices of the USERDA.

SCANNED OCT 04 1997



**Los Alamos Scientific Laboratory**  
The University of California  
LOS ALAMOS, NEW MEXICO 87544

Equal Opportunity Employer

RECENT PROGRESS IN INERTIAL CONFINEMENT FUSION RESEARCH  
AT THE LOS ALAMOS SCIENTIFIC LABORATORY\*

by

R. B. Perkins  
Los Alamos Scientific Laboratory  
University of California  
Los Alamos, New Mexico 87545

ABSTRACT

The Los Alamos Scientific Laboratory is pursuing an integrated research and development program in inertial confinement fusion based on the use of the carbon dioxide gas laser. Achievement of this goal requires early demonstration of scientific breakeven, where the fusion yield equals the laser energy incident on the fuel pellet. We plan to demonstrate breakeven in 1983 with the 100 kJ Antares CO<sub>2</sub> laser currently under construction. Our success in this goal will lead to serious consideration of the CO<sub>2</sub> laser as the driver of choice for inertial fusion.

The Los Alamos Inertial Confinement Fusion Program has three main thrusts: development of the high power, short pulse lasers needed for target experiments; target experimentation, requiring sophisticated target design, target fabrication, and diagnostic development; and systems studies to identify potential design for commercial reactor systems, and to provide an early identification of problems that will have to be overcome. Recent progress in the program has been significant. Plans have been formulated to achieve scientific breakeven with CO<sub>2</sub> lasers by 1983.

\*Work performed under the auspices of the U.S. Department of Energy



RECENT PROGRESS IN INERTIAL CONFINEMENT FUSION RESEARCH  
AT THE LOS ALAMOS SCIENTIFIC LABORATORY

by

R. B. Perkins  
Los Alamos Scientific Laboratory  
University of California  
Los Alamos, New Mexico 87545

Introduction

The Los Alamos Scientific Laboratory is pursuing an integrated research and development program in inertial confinement fusion based on the use of the carbon dioxide gas laser. Achievement of our goals requires early demonstration of scientific breakeven, where the fusion yield equals the laser energy incident on the fuel pellet. We plan to demonstrate breakeven in 1983 with the 100 kJ Antares CO<sub>2</sub> laser currently under construction. Our success in this goal will lead to serious consideration of the CO<sub>2</sub> laser as the driver of choice for inertial fusion. The CO<sub>2</sub> laser has a demonstrated efficiency of over 2%, with a potential of up to 10%, and, because it employs a gaseous laser medium, can be engineered to operate at the high repetition rates that will be required for commercial power generation.

The Los Alamos Inertial Confinement Fusion program has three main thrusts: development of the high power, short pulse lasers needed for target experiments; target experimentation, requiring sophisticated target design, target fabrication, and diagnostic development; and systems studies to identify potential designs for commercial reactors and other applications, and to provide an early identification of problems that will have to be overcome.

The Los Alamos inertial confinement fusion program has developed a strong program logic involving nine major milestones culminating in scientific breakeven in 1983 (Fig. 1).

Six of these milestones involve target performance, which in turn are dependent on three milestones related to major facilities, since from its inception, the target program has been laser power limited. I will discuss first the current status and future promise of our CO<sub>2</sub> laser development program.

#### Advantages of CO<sub>2</sub> Gas Lasers for Inertial Confinement Fusion

We believe the CO<sub>2</sub> gas laser offers significant advantages for inertial fusion (Fig. 2). Electrical efficiency is high compared to other lasers. The Eight-Beam System at Los Alamos has an efficiency of 2%. Short-pulse extraction efficiencies of up to 10% in future systems are possible by the use of multiple-pulse energy extraction.

The gas medium of the CO<sub>2</sub> laser eliminates concerns of damage to the medium that arise in solid-state lasers and the gas is easily exchanged by flow to provide cooling. Thus, the laser medium is not the controlling element for high repetition rates. Incorporation of aerodynamic windows is a possible option to eliminate concern over window damage at high repetition rates if this proves to be a problem. Long-pulse CO<sub>2</sub> lasers have been operated at repetition rates of 750 Hz by AVCO-Everett. With present technology, short-pulse CO<sub>2</sub> lasers can be operated at a few hertz and operation at 10 to 50 Hz appears to be feasible.

CO<sub>2</sub> laser systems of a given power are more compact than Nd:glass, as I will be illustrating with some photographs of systems that are under construction at Los Alamos. We believe that CO<sub>2</sub> lasers will be scalable to the energy levels of 1 to 10 MJ believed to be required for commercial power-plant devices.

## Development of High Power CO<sub>2</sub> Lasers at Los Alamos

LASL is constructing a sequence of short-pulse, CO<sub>2</sub> lasers for inertial fusion research (Fig. 3). The vertical scale of the figure is in units of 10<sup>12</sup> watts or terawatts, a terawatt corresponding to an energy of a kilojoule delivered in one nanosecond. The output pulse width is variable from 0.25 ns to 1 ns. With current design predictions, scientific breakeven (fusion energy output equaling laser energy incident on the pellet) is expected at an incident power of less than 100 TW. The Single-Beam System has provided much information on absorption of CO<sub>2</sub> light in materials. The Two-Beam System, which began operation with both beams December 1976, was designed to be the prototype for the final amplifiers of the Eight-Beam System (EBS). In addition to its original design objective, it has been used for compression experiments at powers up to 1.0 TW during the past year. Much has been learned from the operation of this prototype which has improved the design of the EBS. The EBS is in the final stages of construction and is undergoing subsystem testing. It will begin initial operation in April 1978 and will permit us to study ablative compression of pellets to complete and optimize the design of the breakeven target. The Antares laser system will be housed in our High Energy Gas Laser Facility (HEGLF). It will provide 100 to 200 TW of power and should permit breakeven to be reached, based on our present calculations.

Figure 4 shows an artist's conception of the Eight-Beam System (Ref. 1). Four dual-beam modules provide eight laser beams to a central target chamber. Design point is 10 kJ in 1 ns (10 TW), or 5 kJ in 0.25 ns (20 TW). The output pulse characteristics are a function of the driver pulse, which is produced in the front-end room, and the nonlinear properties of the gain

medium and saturable absorbers deployed throughout the amplifier systems. The entire facility is monitored and fired by a computer-based control system. Target experiments are monitored by a separate data-acquisition system. Figure 5 is a recent photograph of the main target room. Installation of the target chamber and beam optics is nearing completion. The short-pulse front end is complete and has successfully passed a subsystem integration test recently. The eight amplifiers have been fired separately and simultaneously. Energy has been extracted from one of the beams into a calorimeter--1250 J were produced in a single-nanosecond pulse, demonstrating design point operation of the final amplifier. Recent measurements of output energy as a function of input pulse length has confirmed our expectations regarding output pulse length. We believe that these results have demonstrated already that one beam of the EBS is the most energetic single beam, short pulse CO<sub>2</sub> laser in existence. We expect to complete the full system and be ready for initial experiments by April.

A serious problem was encountered in the initial operation of the dual beam modules, namely, the parasitic oscillations due to optical feedback. Because practical large-aperture Faraday rotators do not currently exist for the 10- $\mu$ m wavelength, this technique, which is standard at 1  $\mu$ m, is not available to us. In fact, any high-efficiency high-power laser based upon conventional concepts faces a difficult parasitic suppression problem, since small signal gains exceed large signal gains by many orders of magnitude. Consequently, we have developed an isolation technique based on saturable gas absorbers which appears to be adequate to eliminate parasitic modes throughout the system while still permitting design-point energy output.

## Antares - The Breakeven CO<sub>2</sub> Laser

Design and construction of Antares (Ref. 2), which will operate at power levels of 100 to 200 TW, is well underway (Fig. 6). This large CO<sub>2</sub> laser system, with which we intend to demonstrate scientific breakeven, consists of an oscillator-preamplifier subsystem, six power amplifiers, beam tubes, and a target chamber. The figure is a photograph of a scale model of the facility. The oscillator-preamplifier, housed in a basement under the main laser hall, incorporates a high contrast-ratio electro-optical switchout and saturable absorbers between preamplifiers. The optical pulse is amplified to 100 kJ by six power-amplifier modules. After leaving the power amplifiers, the six high-energy beams are transported through evacuated beam tubes to a building containing the target chamber. The target building is shielded as required by the anticipated thermonuclear yield. The power-amplifier modules (Fig. 7) are electron-beam controlled annular discharge chambers of about 3000-liter pumped volume at 2.4-atm pressure of CO<sub>2</sub>-N<sub>2</sub> gas mixture. The optical design in the power amplifiers is a two-pass layout which requires 36-J input to extract 80% of the stored energy in 1 ns. The large copper-plated aluminum mirrors used throughout the system are single-point diamond turned at the Y-12 plant of Union Carbide Corporation in Oak Ridge. The large 18" diameter NaCl windows used in the output of the power amplifier modules were developed and will be produced by Harshaw Chemical Corporation. Control will be by computer and all intercommunications of the control signals will be by means of fiber-optic links to avoid electrical noise interference problems.

A prototype of the power-amplifier module has recently completed successful testing at Los Alamos. This program confirmed the soundness of the basic Antares design with regard to the electrical and optical parameters. Operation at voltage exceeding 500 keV with optical gain coefficient exceeding the design value gain length product of six were demonstrated. Measurement of the magnetic field effects confirmed the design calculations with regard to this effect.

Procurement of the first of the six power amplifier modules will begin this spring, with final tests on a single beam to be completed in October 1981. In parallel, the remaining beams will be constructed for final facility completion in October 1982.

#### Suitability of CO<sub>2</sub> Lasers for Inertial Fusion

In the recent past, there was a belief that even though CO<sub>2</sub> gas lasers offered the needed characteristics of efficiency, repetition rate, and power for laser fusion, the wavelength was unsuitably long. This led to the search for the so-called Brand X laser, with a wavelength well below 1  $\mu\text{m}$  desired. Recent results at LASL (Ref. 3) and elsewhere have strongly mitigated the earlier objections and make the CO<sub>2</sub> laser a very attractive candidate for early demonstration of scientific feasibility and eventual commercialization (Fig. 8), while processes such as stimulated backscatter (Ref. 4) <sup>→ no  $\lambda$  depend. (50% mod)</sup> may make short wavelength lasers unsuitable for laser fusion.

Much of our recent experimental and theoretical efforts have concentrated primarily on the wavelength scaling problem, i.e., on answering the question of whether the long CO<sub>2</sub> wavelength, 10- $\mu\text{m}$ , is appropriate for laser



fusion. Let us first review the previous objections to long wavelengths. Consider the plasma blow-off cloud, which is created almost instantly when a high-energy laser pulse impinges on a target pellet. The laser light does not penetrate beyond the so-called critical density, i.e., beyond the point at which the index of refraction equals zero, or expressed differently, where the local plasma frequency equals the incident laser frequency. Because of the scaling of the critical density inversely as the square of the wavelength, the 10- $\mu\text{m}$   $\text{CO}_2$  light penetrates to a density 100 times lower than the density to which 1- $\mu\text{m}$  Nd:glass laser light penetrates. (It should be noted that even 1- $\mu\text{m}$  light only penetrates to electron densities nearly 100 times less dense than that of solid targets. Any light of wavelength longer than  $\sim 0.2 \mu\text{m}$  is then absorbed on a "plasma beach" in front of the target leading to complex absorption and transport problems still incompletely understood.) For a hydrodynamically expanding plasma, the  $\text{CO}_2$  light would, according to this picture, be absorbed at a much larger radius, and correspondingly lower plasma density so that the energy deposited per particle would be much higher than for absorption of 1- $\mu\text{m}$  light.

It was believed that  $\text{CO}_2$  laser light would therefore generate very energetic (suprathermal) electrons of long range and cause severe preheat of the target core. Isentropic compression of the preheated fuel to the necessary density would thus become much more difficult and require much more energy. The extent of this preheating was not known and could be assessed only if the energies of the suprathermal electrons were known.

Several methods of determining the electron energies have been devised. In one method, it was assumed that the maximum ion energies and their velocities are related to the suprathermal electron energies of the target.

It was found that at comparable flux densities of about  $10^{15}$  W/cm<sup>2</sup>, the maximum ion velocities observed with Nd:glass and CO<sub>2</sub> lasers were about the same. Measurements of high-energy x-ray spectra from both Nd:glass and CO<sub>2</sub> laser experiments indicated that little difference between the two existed because the hot-electron temperatures, which characterize the suprathermal electron distributions, were similar.

Assuming a single temperature electron distribution in the absorption region led to the past conclusion that the ponderomotive force could be neglected. However, in the past three years it has been realized that the two component electron distribution produced by resonant absorption causes the ponderomotive force to be much more important. In particular the relevant pressure ratio is that between the radiation and the cold background plasma. Except at very high intensity the hot electron pressure, although large, does not participate in pressure balance. The ratio of radiation pressure to plasma pressure at the critical density is proportional to the laser intensity times the square of the laser wavelength and inversely proportional to the background (or cold) electron temperature. At  $10^{15}$  W/cm<sup>2</sup>, assuming a plasma temperature of 1 keV, the ratio is 20 for CO<sub>2</sub> laser light and 0.2 for Nd:glass light. Under these conditions, we would expect a plasma profile strongly distorted by the laser pulse, especially in the vicinity of the critical density. In particular, we might expect the CO<sub>2</sub> laser ponderomotive force to drive up a very large density step whose upper density might be comparable to the critical density for Nd:glass light. This could explain the similarity of experimental results for the two wavelengths.

We have combined all the data we could find on hot-electron temperatures and plotted them versus light flux,  $P_L$ . All the points for a given wavelength seemed to lie on a single curve. However, when we plotted the data as a function of  $P_L \lambda^2$ , all the data points fell onto a single curve, characterized by three regions of different slopes (Fig. 9). The upper region, where strong profile-modification effects are likely due to the high ratio of ponderomotive pressure to plasma pressure, is of the greatest interest for our present argument. Here, the slope of the curve is  $\sim 0.25$ , implying that the hot-electron temperature is approximately scaling as the square root of the wavelength. Similar results are obtained in particle-in-cell computer simulations (slope  $\sim 0.3$ ) and by other compilers (slope  $\sim 0.3$  to  $0.4$ ). Thus, it appears that  $\text{CO}_2$  laser light may be nearly as *external targets* satisfactory for laser-fusion purposes as Nd:glass laser light and raises the question of whether a Brand X laser of a short wavelength is really needed.

#### Target Experiments: Recent Progress

Verification of the suitability of  $10\text{-}\mu\text{m}$  radiation to compress thermonuclear fuel pellets to fusion conditions must await the availability of suitable, high-power lasers, such as the Eight-Beam System and Antares. We have carried out an extensive experimental program during the past year on our two operational laser systems. The Single-Beam System (SBS) operated at energies of about 150 joules with a 1 ns pulse length until it was shut down in December, 1977. Many experiments relative to both basic laser-plasma interaction (e.g., absorption, electron and x-ray spectra, fast ion production) and target design (e.g., vacuum insulation) were carried out. The Two-Beam System has been used primarily for two-beam compression experiments on DT gas-filled glass microballoon (GMB) targets at power levels ranging up to 1 TW.

Results on DT-fueled GMB targets demonstrated the first definitive CO<sub>2</sub> laser-induced fusion reaction early in 1977 (Ref. 5). More recent results over a range of power, size, and fuel loading parameters have permitted comparisons with predictions of the LASNEX computer code.

Our results have also demonstrated an independence of neutron yield on wavelength: we obtain similar yields from CO<sub>2</sub> laser-driven targets when compared to Nd:glass laser-driven targets at the same incident power level. To make this comparison most convincingly, we used a simple analytic scaling model (Ref. 6, see also Ref. 7) which is consistent with LASNEX and with experimental results. In Giovanielli's model (Fig. 10), neutron yield Y is a function of the initial GMB radius r, wall thickness Δr, fuel density ρ<sub>f</sub>, shell density ρ<sub>s</sub>, and of the useful specific energy (E/M)

$$Y = K F\left(\frac{E}{M}\right) \text{ where } K = \left(\frac{r}{r_0}\right)^{10/3} \left(\frac{\Delta r}{\Delta r_0}\right)^{2/3} \left(\frac{\rho_f}{\rho_{f_0}}\right)^{4/3} \cdot \left(\frac{\rho_s}{\rho_{s_0}}\right)^{2/3} .$$

The parameters  $r_0$ ,  $\Delta r_0$ ,  $\rho_{f_0}$  and  $\rho_{s_0}$  are normalization values.

The useful specific energy is the net absorbed energy per unit mass that arrives before the minimum radius is reached. The normalized neutron yield, Y/K, when plotted against the E/M appears to have the simple power dependence shown in Fig. 11, with the dependences on target size and fill parameters all contained in K. The wavelength independence over a significant range of yield is very striking, and is independent of any shortcomings of the model. Of course, we must continue the comparisons to ensure performance at the higher power levels required for breakeven and higher gains.

To assure that the computer predictions of pellet performance can be trusted, it is important to carry out experiments that test various aspects of the LASNEX program and to calibrate the validity of the assumptions and approximations that are necessarily made to permit the calculations to be performed on existing computers. An example is to study the details of compression using one or more of the nuclear or atomic radiations as a signature of what is occurring inside the pellet. Using the Two-Beam System at Los Alamos we have observed low-energy x-ray spectra from DT-filled glass microballoon targets to which 10% neon is added. The spectrometer consists of a TAP flat crystal so that on the film the image was a projection of the wavelength in one dimension and the object spatial extent in the other dimension (Fig. 12). A number of x-ray lines have been identified from the system, including neon lines from the fuel region and silicon lines from the glass microballoons. Note that the spatial width of the neon lines corresponds to about 50  $\mu\text{m}$  compared to the original 180- $\mu\text{m}$  diameter of the fuel region, whereas the silicon lines on the spectrograph are wider. Thus, such data are consistent with an interpretation in which the neon emanations come from a localized fuel compression region; whereas the silicon lines arise from the glass that is both imploded and exploded by the laser pulse.

Quantitative study of such data can tell us where the high-temperature burn regions are located and to what extent they are consistent with predictions. In the near future we hope to deploy x-ray streak cameras to obtain temporal histories of x-ray emissions as well.

The absorption of 10- $\mu\text{m}$  light on plane and spherical targets was recently measured. Using an elliptical reflector (Fig. 13), reflected light is integrated to derive the fraction of the incident light absorbed by the target.

For flat targets, we have found that  $45 \pm 7\%$  of the incident light is absorbed, independent of the atomic number of the absorber and independent of the incident irradiance over the range of intensity,  $10^{12} - 3 \times 10^{14} \text{ W/cm}^2$  (Refs. 8 and 9). Other laboratories have conducted similar experiments on absorption over the past year. Our results at  $10 \mu\text{m}$  are in excellent agreement with  $10\text{-}\mu\text{m}$  measurements at NRC (Canada) and, further, agree with similar experiments at  $1 \mu\text{m}$  at the Naval Research Laboratory, Max-Planck-Institut für Plasmaphysik, and Lawrence Livermore Laboratory. This wavelength independence is a relatively surprising result which further substantiates the overall reduced sensitivity of laser-plasma interaction to wavelength in contrast to earlier assumptions. For microballoon targets we have found about 25% absorption for a wide range of target radii and target material.

#### Target Experiments: Future Milestones

With our first milestone of thermonuclear yield and compression complete in 1977 (Fig. 1), we are preparing for experiments on the 10 kJ EBS. After shakedown experiments with exploding pusher targets, we will attempt to reach 20 times liquid density with an ablatively driven target. LASNEX predicts such densities are relatively easily achieved. The experimental problem is to diagnose the density in the fuel since the expected neutron yields are very low. We have a design in hand which we believe to be diagnosable by one of several techniques which will include x-ray back-lighting of the imploding pellet.

With this result in hand, and while awaiting completion of higher resolution diagnostics, we will study thermonuclear burn scaling with targets operating more nearly in an exploding pusher mode. Our calculations indicate that neutron yields in excess of  $10^{10}$  should be achievable with the EBS in 1979.

Next we turn to several advanced designs, including a cryogenic design, to study ablative compression scaling to compressions predicted to be in excess of 100 times liquid density. Depending on our success with the several target types we are considering, we should achieve this milestone by late 1980. We will then turn our attention to studying prototype targets for the breakeven experiments on Antares, not aiming necessarily for the highest yields or compressions that might be achievable with 10 kJ from the EBS, but rather to confirm our computer design predictions and to optimize the target parameters to maximize the likelihood of success when the target is driven by Antares. The prototype target testing and optimization will be carried out during final installation and checkout of Antares during 1981 and 1982.

Upon completion of Antares in October 1982, we expect to achieve breakeven within the following year. Our calculations on some target designs indicate the possibility of higher gains, perhaps as high as 5 or 10, but clearly we have much to learn over the next few years with the EBS.

#### System Studies of Commercial Power Plants

Turning now to the third component of our program, we are actively engaged in studies of potential systems for commercial energy production from inertial confinement. The path to scientific breakeven and commercial feasibility will be long and difficult, but the potential payoff is so large that a vigorous effort is justifiable.

I will not attempt to exhaustively review our past systems work, for it has been reported in the literature (Ref. 10). But I would like to address a couple of specific issues and indicate our recent thoughts (Fig. 12).

On the matter of laser efficiency and required pellet gains, we have examined via a model the relative production cost of electricity from our wetted-wall laser fusion reactor design, taking into account not only the operating costs but also plant amortization. We find for a given laser efficiency, an optimum pellet gain. This rather surprising result arises primarily from the larger capital cost of a cavity capable of standing the larger explosion.

Also, assuming a thermal-to-electrical conversion efficiency of 30%, a 5% efficient laser requires a pellet gain of 200 whereas a 20% efficient laser requires a pellet gain of 100. Thus, required pellet gain is relatively insensitive to laser efficiencies greater than about 5%.

What are the prospects for CO<sub>2</sub> laser efficiency? Our Eight-Beam System, presently nearing completion, has an electrical efficiency of 2%. The Eight-Beam System delivers pulses of less than 1 ns. As we go to the larger yields required for commercial use, longer pulse lengths will be appropriate to match the larger targets. Assuming that a pulse duration of 10 ns might be acceptable, the electrical efficiency should rise to 4 to 5%. We are also considering techniques of amplifying multiple pulses over a time scale of perhaps 1  $\mu$ s. Figure 15 depicts the expected efficiency as a function of the number of pulses amplified at 250-ns intervals. An overall efficiency of at least 10% should be possible if four pulses are extracted in a microsecond. Such efficiencies might be realized if one piped the pulse to different chambers, or combined the pulses with optical delays into a single fusion chamber. One realization of this concept has each pulse traversing the amplifier at a slightly different angle, so that each optical path will be distinct and, hence, will permit the pulses to be handled separately. A two pass scheme has recently been discussed by Conn (Ref. 11) who predicts an overall efficiency of 6.7%.



Various containment concepts have been investigated, such as the LASL wetted-wall scheme (Fig. 16) which we currently favor. Here, the reaction chamber is spherical and is surrounded by a lithium blanket. The cavity wall is made of a porous refractory metal which permits molten lithium to flow into the cavity and to form a protective film on the inner surface. This film is partially ablated by each pellet microexplosion, and the evaporated lithium is exhausted through a supersonic nozzle into a condenser. For a 100-MJ microexplosion, the chamber must have a diameter of at least 3.4 m to avoid overheating of the wall by x-ray energy deposition. At this diameter a 0.1-mm-thick film of lithium would be vaporized by each microexplosion, but could be restored in a fraction of a second by inward flow.

A crude vacuum must be maintained (0.1 torr) to avoid refraction and optical breakdown by the incident laser light. Analyses of the blow-down phenomena indicate that about one second is required to restore the cavity to this condition after each microexplosion. Therefore, a maximum repetition rate of one per second, or thermal energy output of about 100-MW per reactor, would be appropriate for a wetted-wall reactor concept.

In this design, a tube through the blanket region would be used to inject the pellets. Eight laser beams would provide the pellet illumination. Blanket structures have not yet been designed in detail, because acceptable tritium-breeding ratios can easily be achieved. Microexplosions yielding 100 MJ can be contained without exceeding the fatigue limits of niobium or molybdenum at temperatures up to 1000 K.

Our systems group at LASL has developed a long-range plan (Fig. 17). The plan has three major components: technical feasibility, systems development, and demonstration. The current phase of technical feasibility is research based and requires parallel lines of investigation with different drivers to ensure reasonable probability of success. In our example, we have assumed that the choice of a driver is the CO<sub>2</sub> laser--the choice clearly must be made before the Engineering Test Reactor (ETR) design release and it must also be made before proceeding with the development of a high repetition rate laser unless one is willing to develop in parallel more than one candidate.

In addition to a choice of driver, systems technology and demonstration component decisions must be delayed until actual achievement of scientific breakeven and higher gain performance. Without these data in hand, we cannot answer questions of scalability of pellets and drivers to the requisite energy gains with the required confidence. Thus, over the near term, we must preserve broad programmatic support of the possible routes to scientific feasibility and net energy gain with drivers capable of development into demonstration power plant scale.

Major areas of systems technology development are concerned with long-life, high repetition rate capabilities, including driver and pellet injection, tracking and beam-transport system, pellet fabrication, and reactor and blanket design. Demonstration systems will require 10<sup>5</sup> to 10<sup>6</sup> pulses per day with lifetimes of up to 10<sup>9</sup> pulses.

The particularly stringent requirements needed for a demonstration plant are: pellet-fabrication techniques yielding pellets for a few cents each, pulsed power systems with long lifetimes (more than 100 million cycles) switching hundreds of kilovolts in a few microseconds, and information on the effects of pulsed operation on reactor components. Of particular concern are the radiation damage, cyclic stresses, first-wall protection, and degradation of the last optical element that is unshielded from the microexplosion.

We have avoided mention of the time scale for laser-fusion development because it is strongly dependent on funding and successful achievement of various milestones. But it is clear that demonstration of inertial confinement fusion is unlikely before the turn of the century.

We are continuing systems studies of critical areas and will be refining our estimates of feasibility and costs. As of this date, we do not see overwhelming problems ahead, assuming achievement of scientific breakeven and gains of about 100. However, the overall economic viability of inertial confinement as a commercial power source will depend critically on the details, many of which cannot be adequately specified at this time.

### Conclusion

In summary (Fig. 18), I have outlined our recent progress at Los Alamos and our plans for the future. We have demonstrated compression and fusion yield with CO<sub>2</sub> lasers. The EBS CO<sub>2</sub> laser will permit exploration of target experiments in the 10-20 TW range over the next four years and permit design and optimization of the breakeven target. The Antares 100 kJ CO<sub>2</sub> laser is nearing design completion and is under construction for completion in 1982.

Achievement of breakeven in 1983 will set the stage for commercialization of ICF with CO<sub>2</sub> lasers. Systems studies continue to identify problem areas ahead but encourage optimism that the largest technical problem is the achievement of pellet breakeven. Thus, we believe we are on the threshold of very exciting times for inertial confinement fusion.

I wish to acknowledge my colleagues at the Los Alamos Scientific Laboratory who have contributed the material for this paper and who have carried out the work described.

### References

1. Singer, S., "CO<sub>2</sub> Lasers; An Efficient Driver for Inertial Confinement Fusion," Los Alamos Scientific Laboratory report LA-UR-77-2870, presented at IEEE/OSA Topical Meeting on Inertial Confinement Fusion, February 1978, San Diego, CA.
2. Stratton, T. F., "The LASL 100-kJ CO<sub>2</sub> Laser for ICF Research: Antares," Los Alamos Scientific Laboratory report LA-UR-77-2880, presented at IEEE/OSA Topical Meeting on Inertial Confinement Fusion, February 1978, San Diego, CA.
3. Giovanielli, D. V., Henderson, D. B., McCall, G. H., Perkins, R. B., "Laser Fusion Target Interaction Studies at 10.6  $\mu$ m," Los Alamos Scientific Laboratory report LA-UR-77-1074. Presented at IEEE/OSA Conference on Laser Engineering and Applications, Washington, DC, June 2, 1977.
4. Ripin, B. H., Young, F. C., Stamper, J. A., <sup>NRL</sup> et al., "Enhanced Backscatter with a Structured Laser Pulse," Phys. Rev. Lett. 39, No. 10, 611 (1977).  
*(after a prepulse 2ns, going from 50% to 20% => shaped pulse only; 1.06  $\mu$ m 4.6 J; from undulator in 20.1 m c; 10<sup>15</sup> 16 w/cm<sup>2</sup>)*
5. Cranfill, C. W., "One-Dimensional Computer Simulations of the Implosion of Simple-Shell Targets with the Los Alamos Two-Beam CO<sub>2</sub> Laser," Los Alamos Scientific Laboratory report, LA-6827-MS (June 1977).  
*backscatter large  
of target  
& large  
front s. s.  
for ripin  
Backscatter  
is small*
6. Giovanielli, D. V., Los Alamos Scientific Laboratory (private communication)
7. Storms, E. K., Larson, J. T., Nuckolls, J. H., Ahlstrom, H. G., Bull. Am. Phys. Soc. 22, 1086 (1977).
8. Cottles, V. M., Bull. Am. Phys. Soc., 22, 1090 (1977).
9. Cottles, V. M., Los Alamos Scientific Laboratory reports LA-UR-77-1096 and LA-UR-77-1767.

10. Booth, L. A., Freiwald, D. A., Frank, T. G., Finch, F. T., "Prospects of Generating Power with Laser-Driven Fusion," Proc. IEEE, 64, No. 10, (October 1976).
11. Conn, R. W., et al., "Solase, a Conceptual Laser Fusion Reactor Design," UMFDM-220.

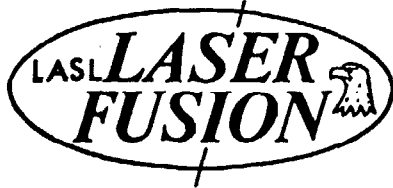

## LOS ALAMOS LASER FUSION PROGRAM MAJOR MILESTONES

BEYOND BREAKEVEN

BREAKEVEN

ANTARES OPERATIONAL

BREAKEVEN PROTOTYPE  
CONFIRMED

ANTARES SINGLE BEAM  
TESTED

ABLATIVE COMPRESSION  
SCALING

TN BURN SCALING

20TIMES LIQUID DENSITY

EBS OPERATIONAL

TN YIELD AND  
COMPRESSION

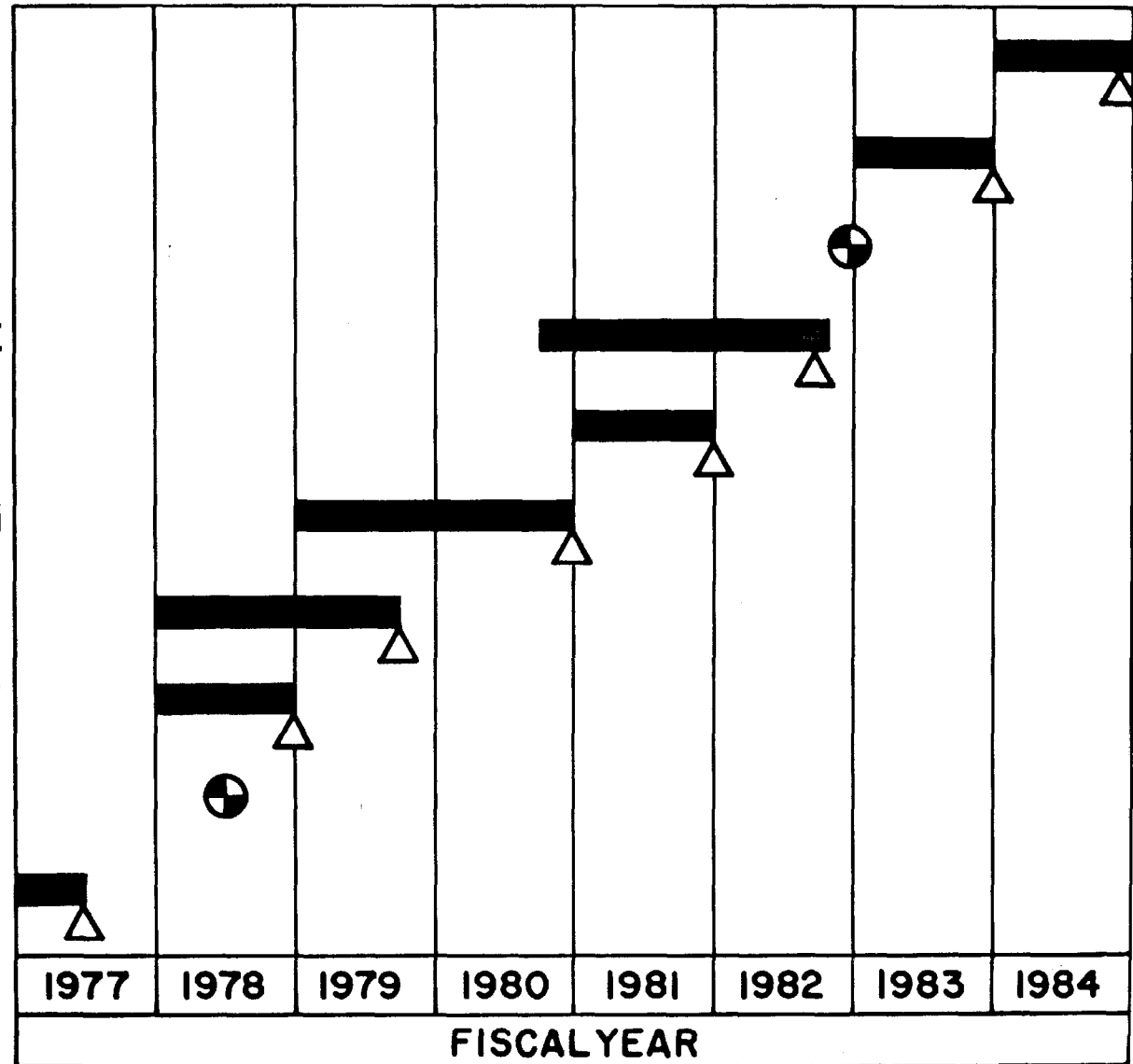

## CO<sub>2</sub> LASERS OFFER SIGNIFICANT ADVANTAGES AS INERTIAL FUSION DRIVERS

---



- EFFICIENCY - 2% AT PRESENT, UP TO 10% IN FUTURE
- DAMAGE-FREE MEDIUM
- REPETITIVE OPERATION
- SCALABILITY - BEING DEMONSTRATED BY LASL PROGRAM

# LOS ALAMOS CO<sub>2</sub> LASER SYSTEMS

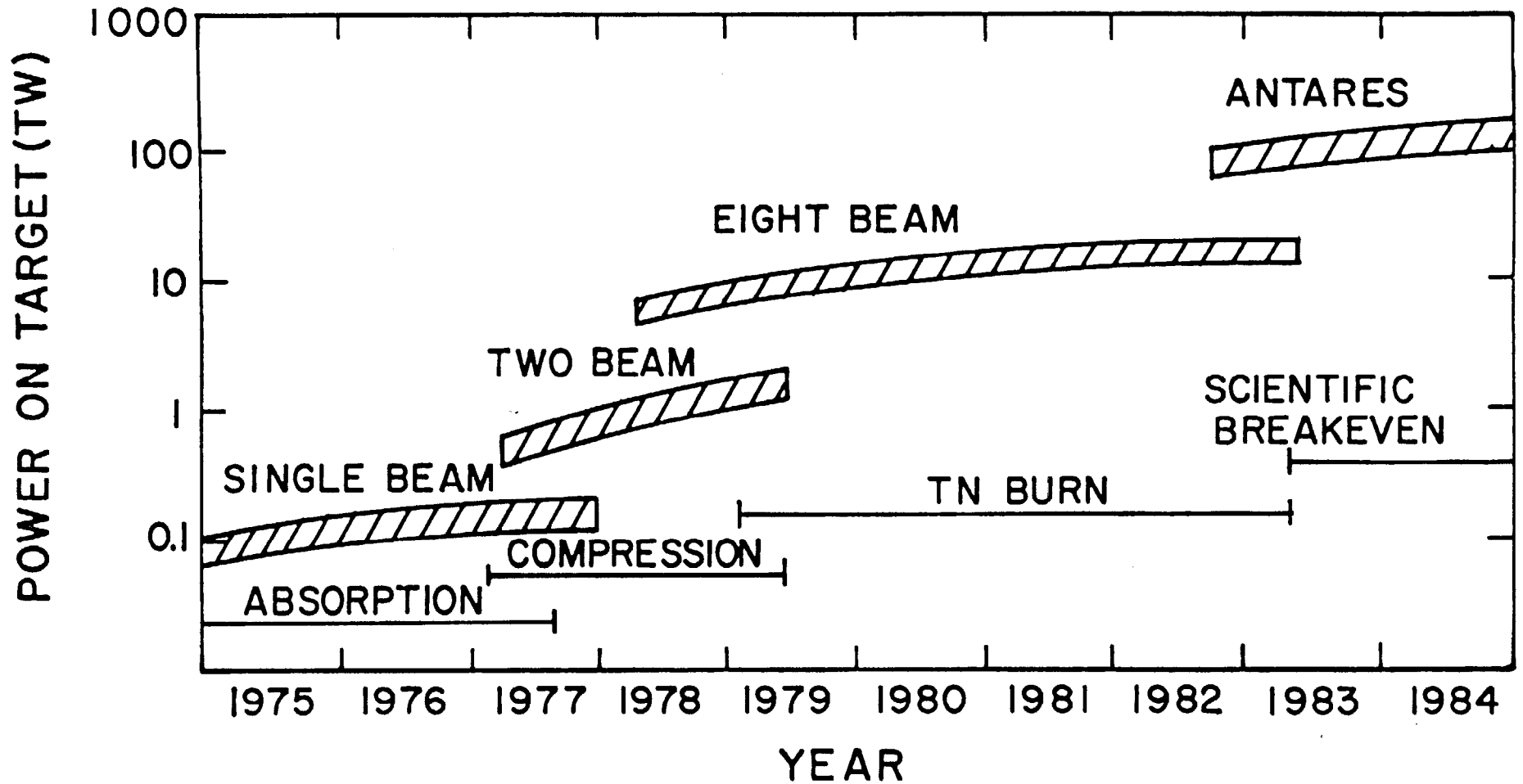



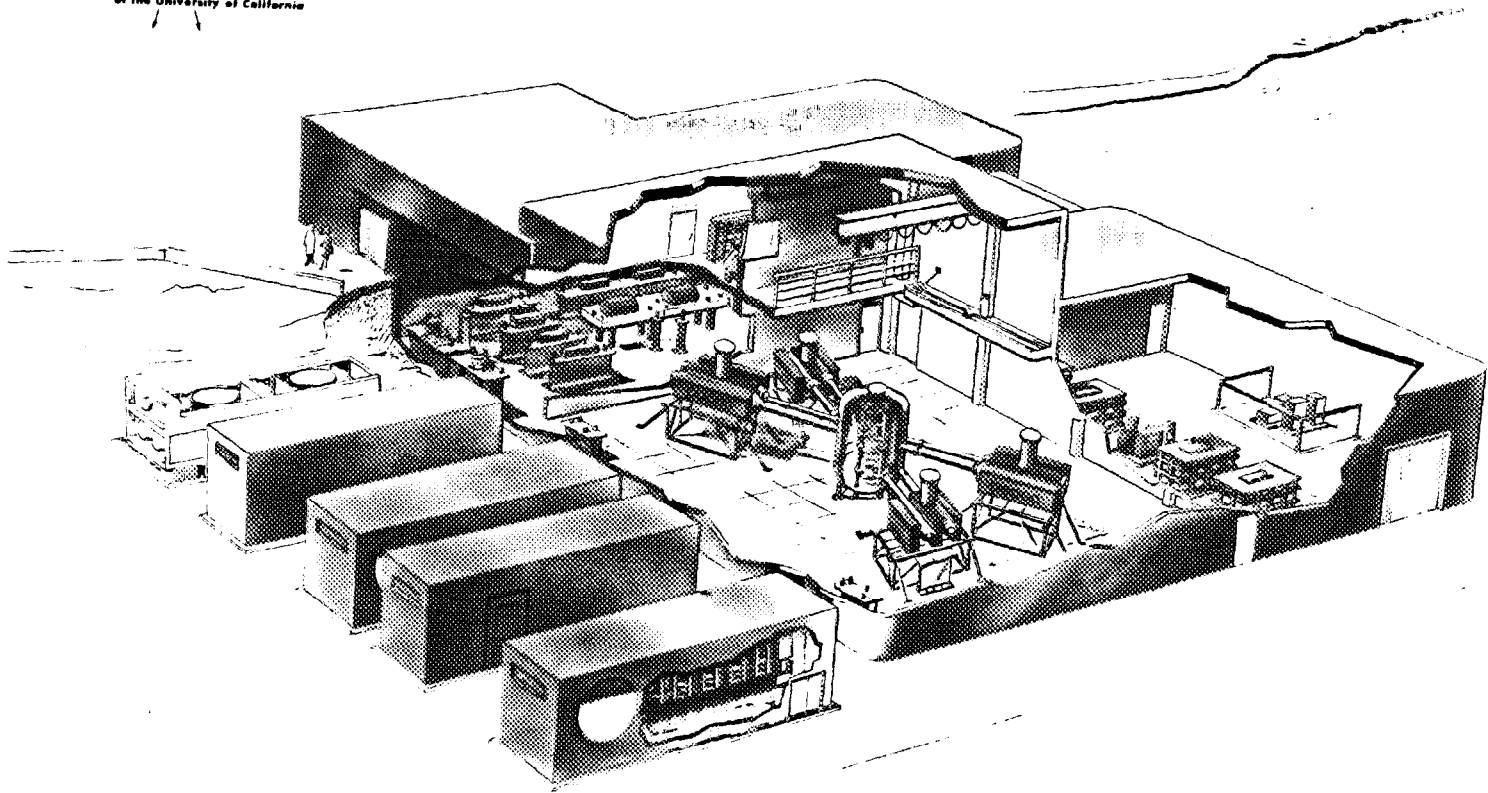

**LASER FUSION LABORATORY**

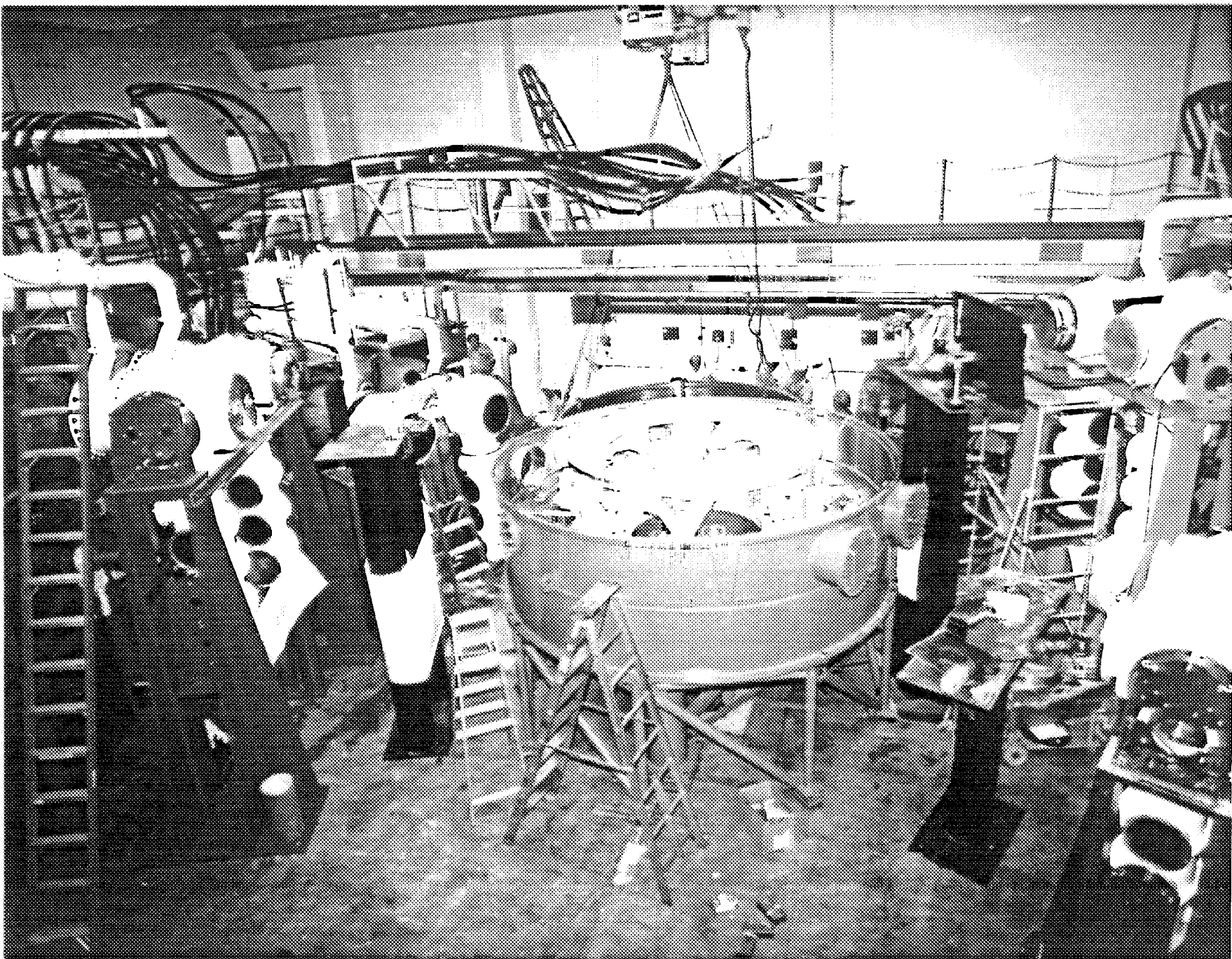

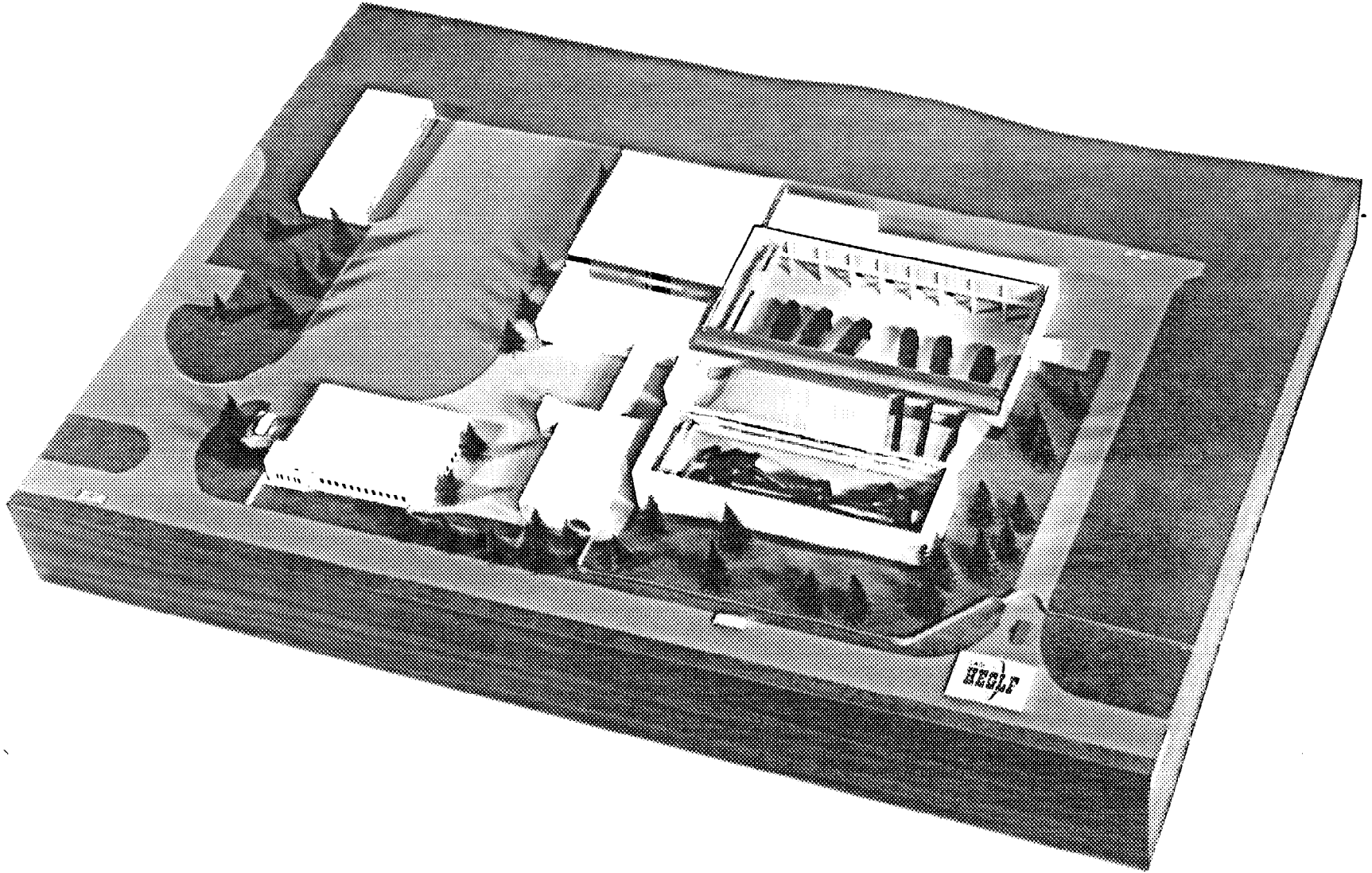

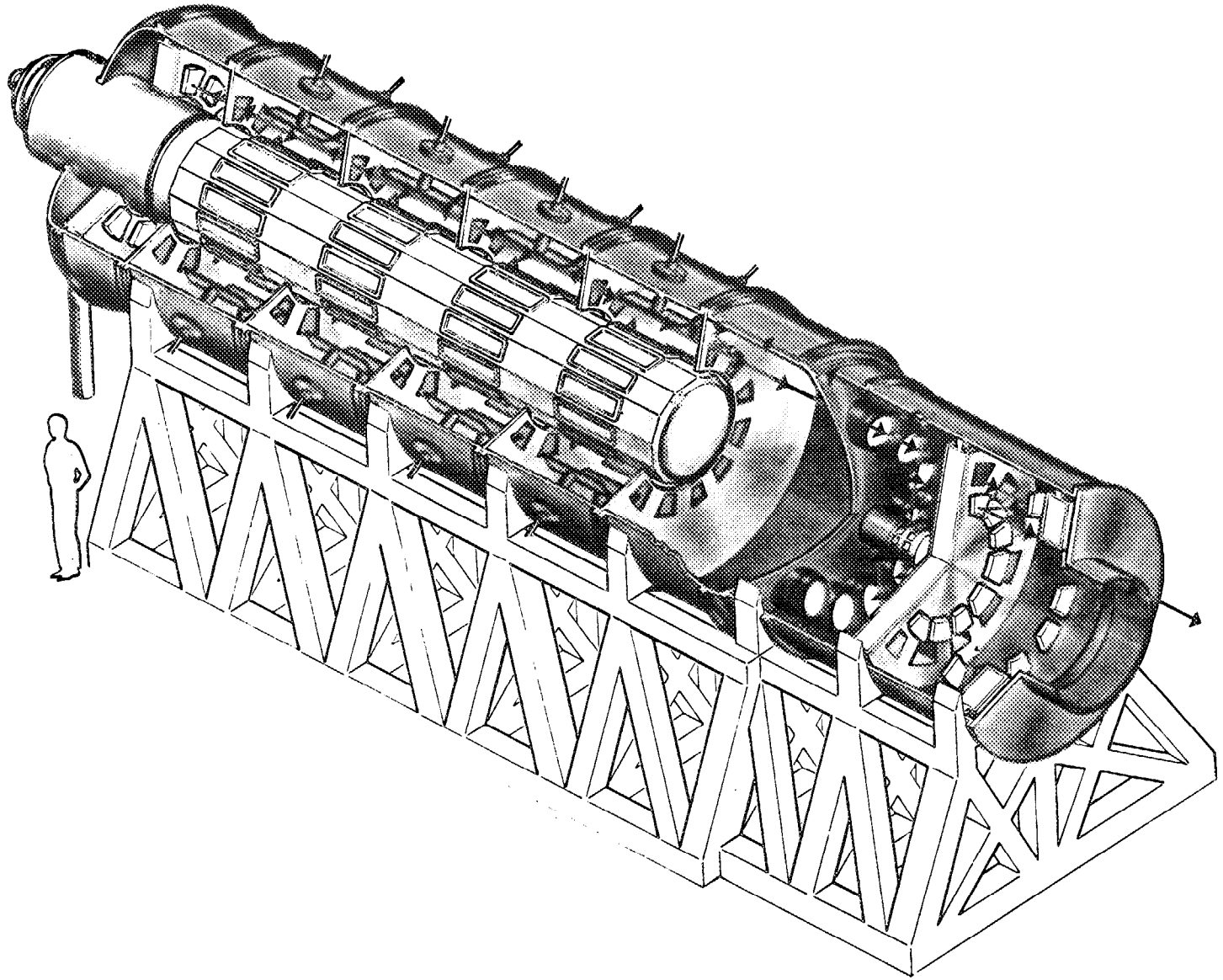

RECENT RESULTS INDICATE THAT 10  $\mu$ m WAVELENGTH IS  
ACCEPTABLE

---



- PONDEROMOTIVE FORCE CAUSES PROFILE MODIFICATION
- HOT ELECTRON TEMPERATURE SCALES AS  $\sim \lambda^{1/2}$
- COMPRESSION EXPERIMENTS INDICATE FUSION NEUTRON YIELD INDEPENDENT OF  $\lambda$  FOR EXPLODING PUSHER TARGETS

# HOT ELECTRON TEMPERATURE VERSUS $P_L \lambda^2$

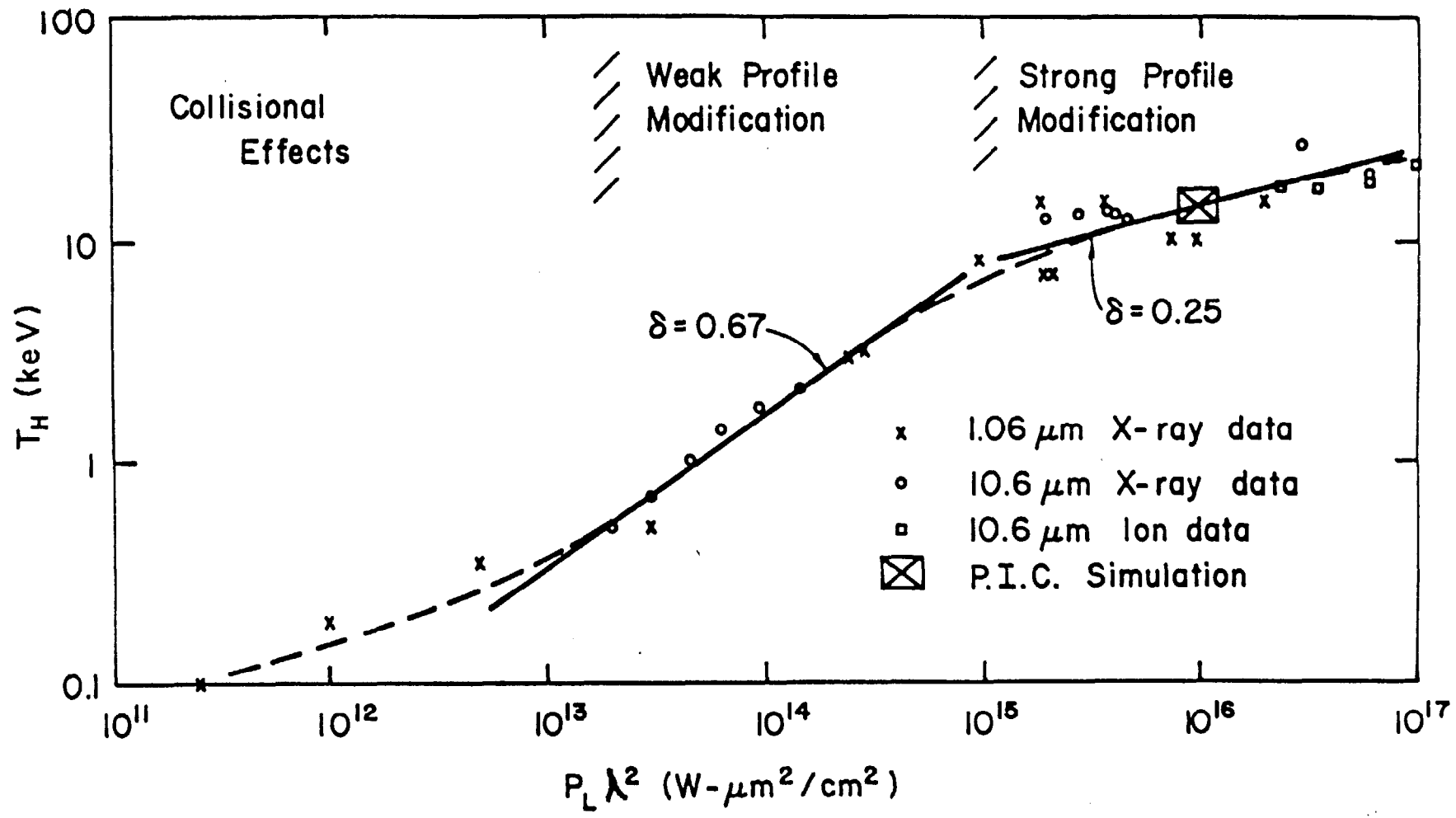

6

GIOVANIELLI'S ANALYTIC SCALING MODEL FOR EXPLODING PUSHER TARGETS



$$Y = K F \left( \frac{E}{M} \right)$$

$$K = \left( \frac{R}{R_0} \right)^{10/3} \left( \frac{\Delta R}{\Delta R_0} \right)^{2/3} \left( \frac{\rho_F}{\rho_{F_0}} \right)^{4/3} \left( \frac{\rho_S}{\rho_{S_0}} \right)^{2/3} = \frac{Y}{Y_N}$$

Y = NEUTRON YIELD

$Y_N$  = NORMALIZED NEUTRON YIELD =  $\frac{Y}{K}$

R = INITIAL GLASS MICROBALLOON (GMB) RADIUS

$\Delta R$  = INITIAL GMB WALL THICKNESS

$\rho_F$  = INITIAL FUEL DENSITY

$\rho_S$  = INITIAL SHELL DENSITY

E = ABSORBED ENERGY DURING IMPLOSION

M = FUEL MASS

$R_0, \Delta R_0, \rho_{F_0}, \rho_{S_0}$  = NORMALIZATION VALUES.

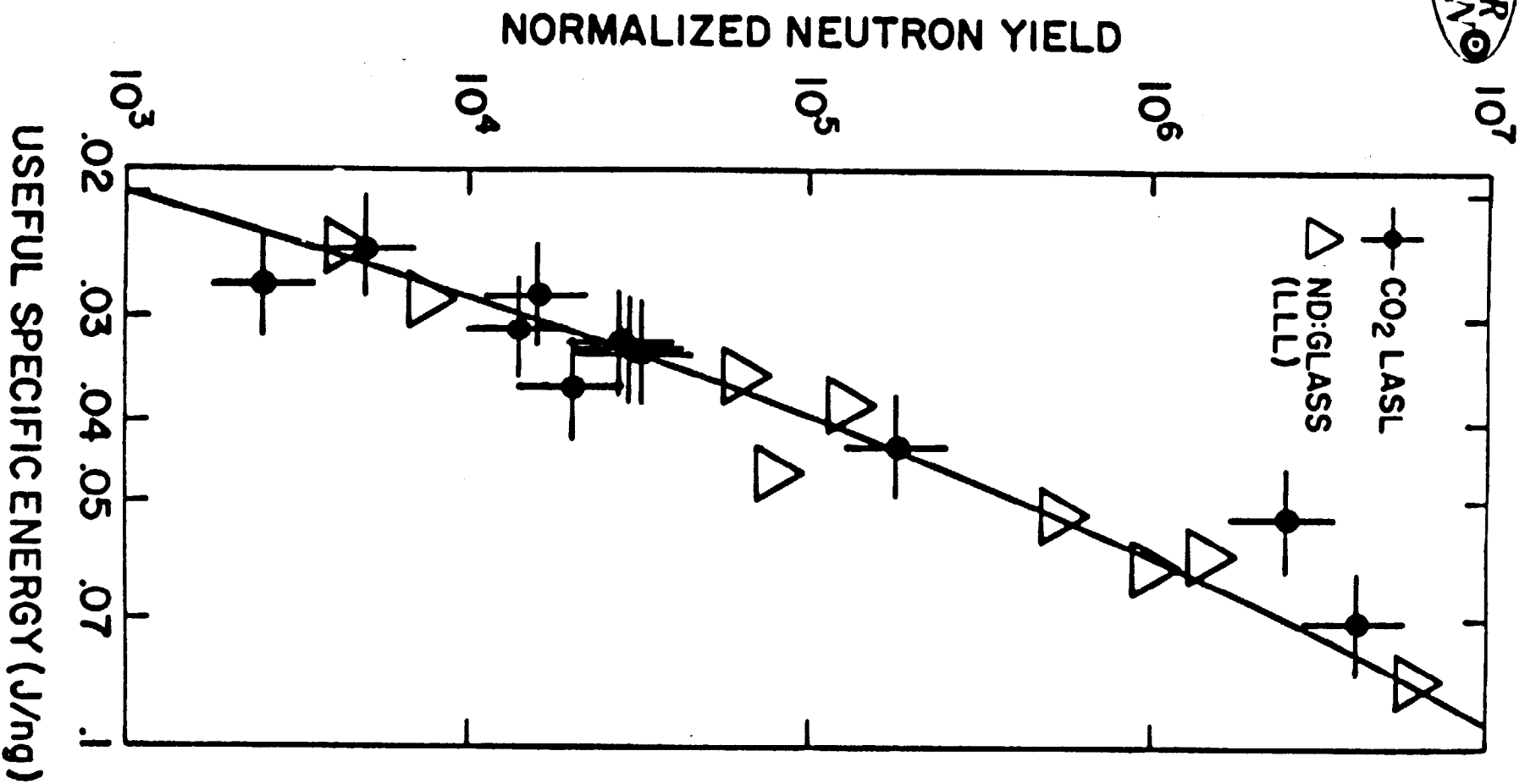



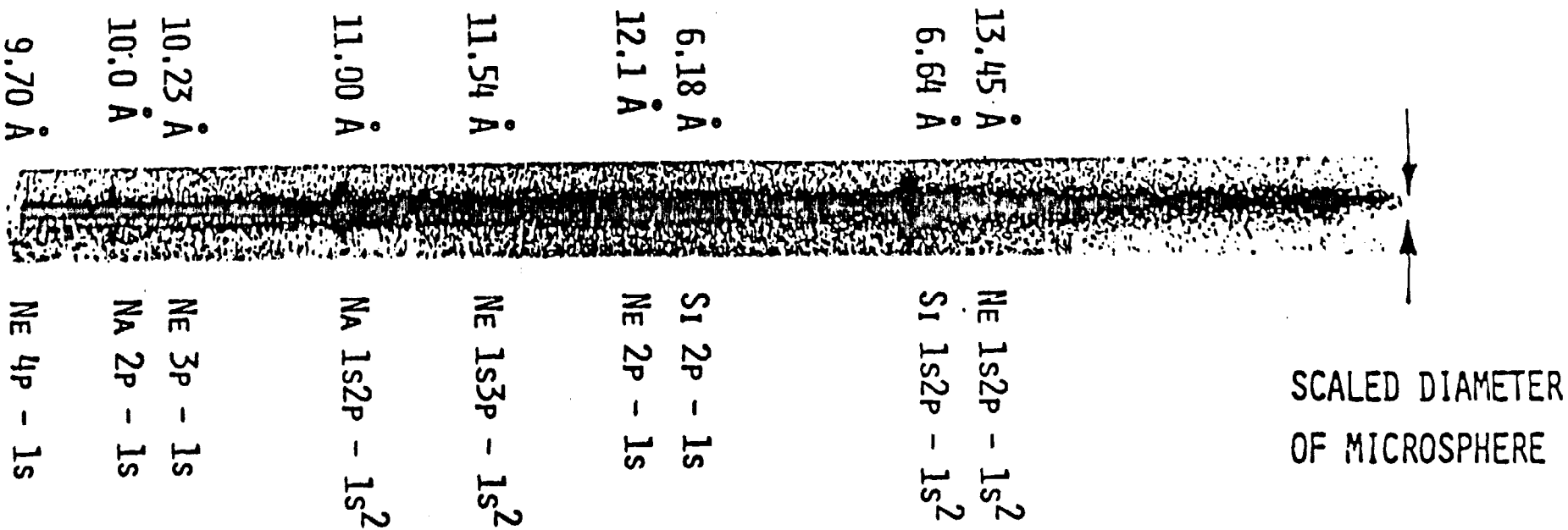

SPECTROGRAM OF PLASMA FROM DT, NE-FILLED GLASS MICROSPHERE TARGET

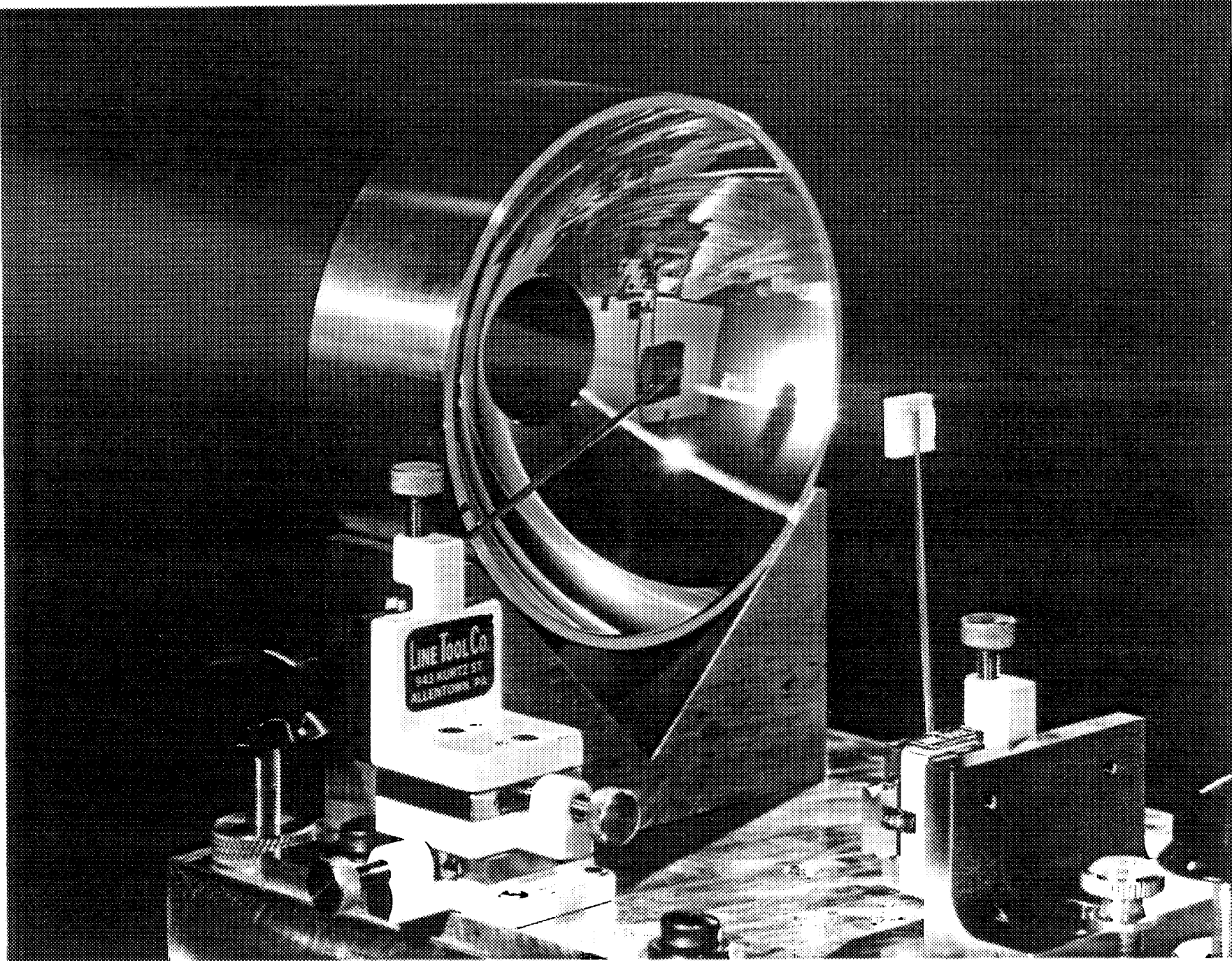

## SYSTEMS STUDIES INDICATE ECONOMIC FEASIBILITY FOR CO<sub>2</sub> LASER DRIVERS

---



- LASER EFFICIENCY OF 5 - 20% REQUIRES PELLET GAINS OF 200 - 100 FOR  $\eta = 30\%$
- CO<sub>2</sub> LASER PROMISES EFFICIENCY OF UP TO 10% WITH MULTIPASSING (MULTIPLE PULSES)
- SEVERAL REACTOR DESIGNS APPEAR POSSIBLE
- PROGRAM PLAN DETAILS SEQUENCE OF REQUIRED STEPS

# MULTIPULSE EXTRACTION PROMISES HIGHER EFFICIENCY FOR CO<sub>2</sub> SHORT PULSE LASERS

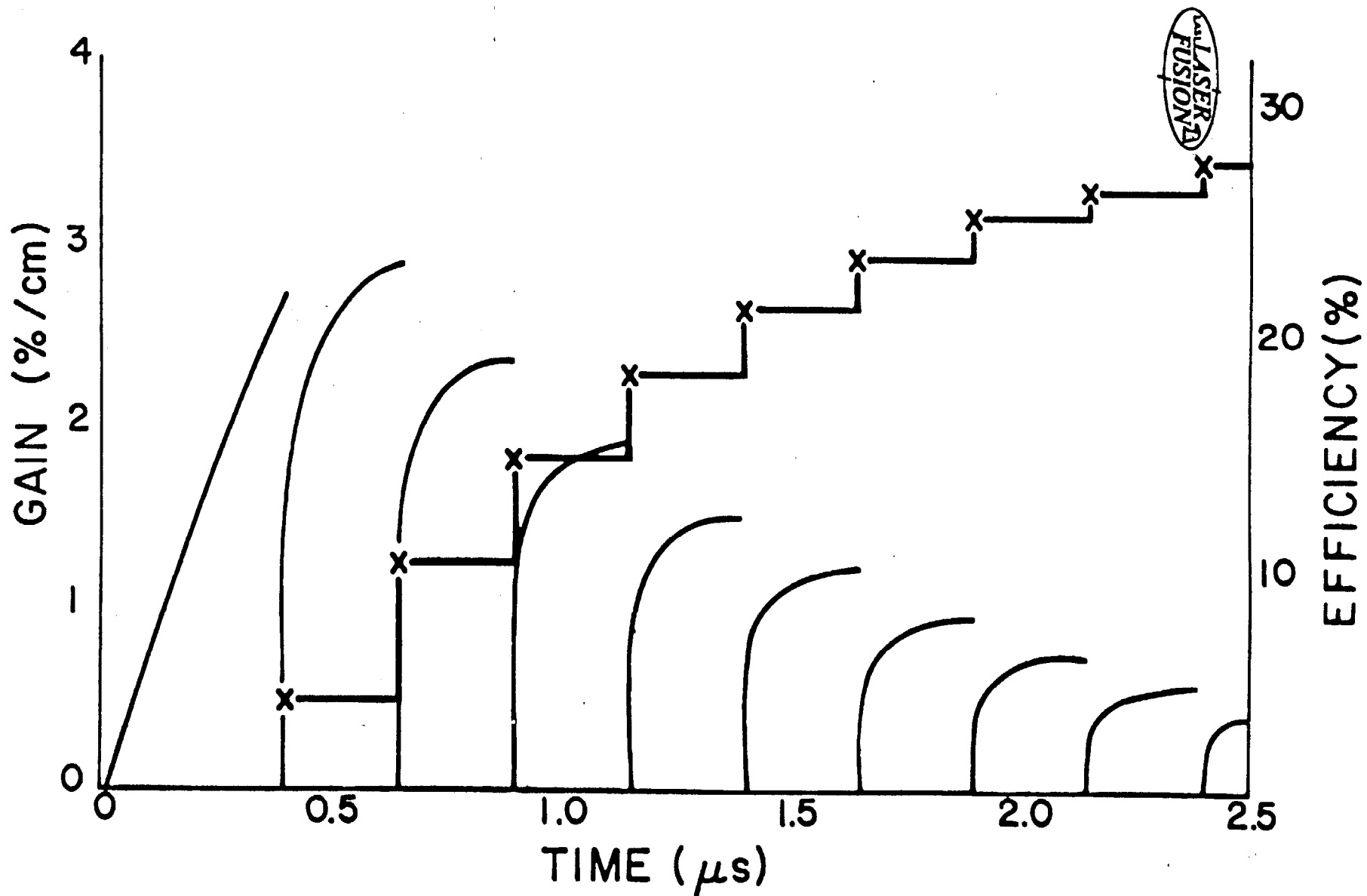

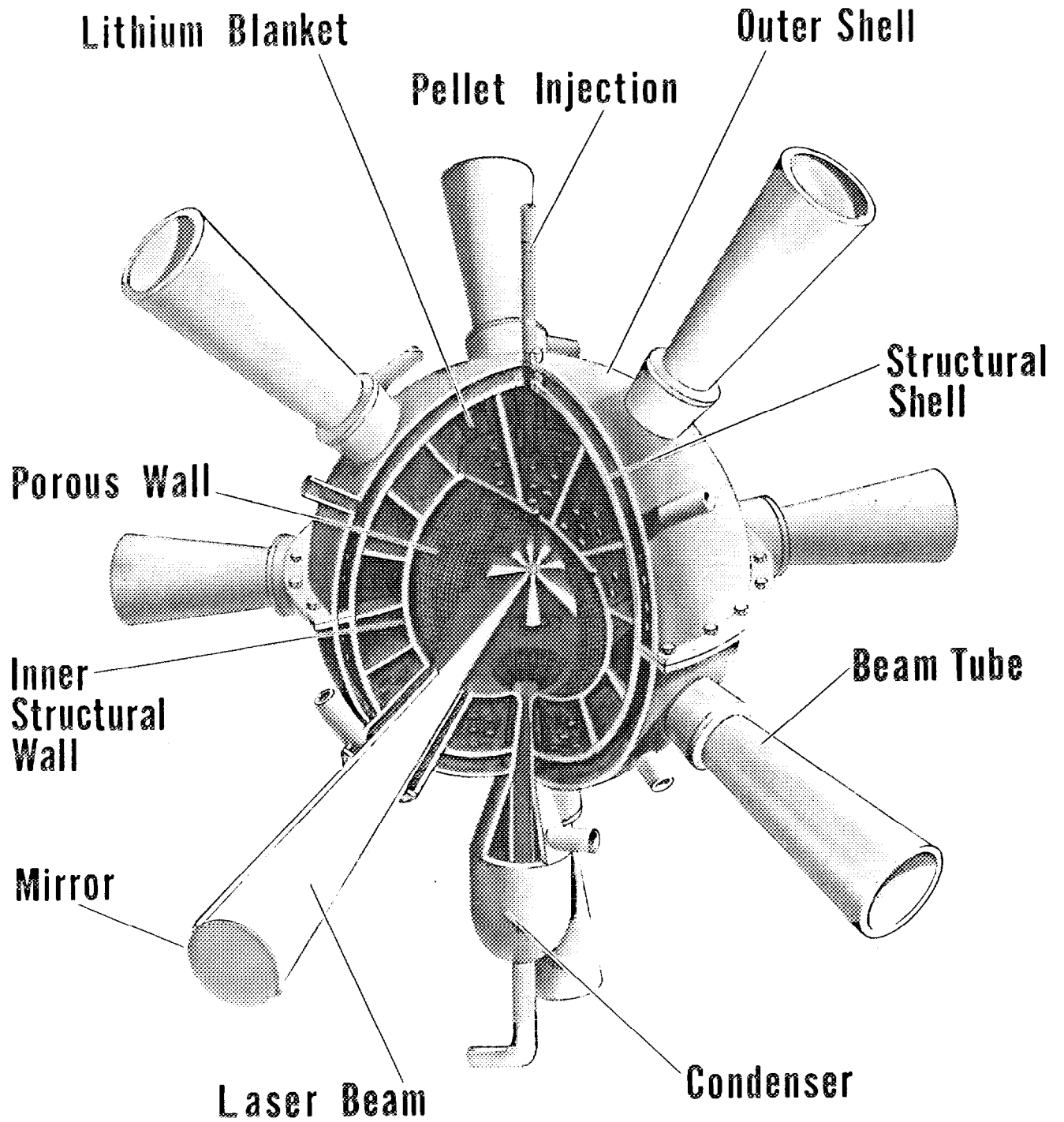

# COMMERCIAL DEMONSTRATION OF INERTIAL CONFINEMENT FUSION

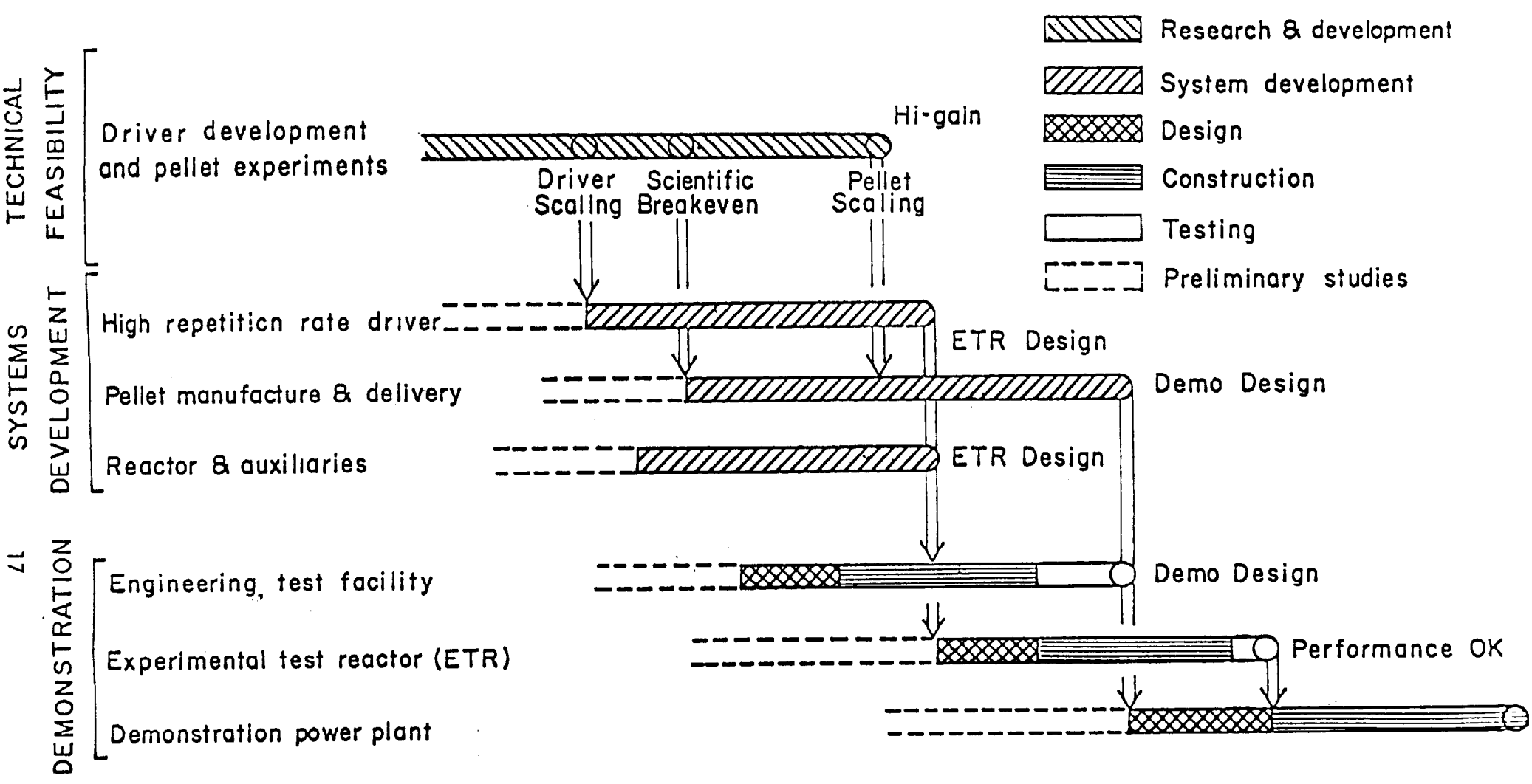

RECENT PROGRESS AT LOS ALAMOS DEMANDS VIGOROUS  
PROSECUTION OF CO<sub>2</sub> LASERS FOR INERTIAL FUSION

---



- COMPRESSION AND FUSION YIELD WITH CO<sub>2</sub> LASER LIGHT DEMONSTRATED AT LOS ALAMOS IN 1977
- EBS 10 kJ CO<sub>2</sub> LASER OPERATIONAL APRIL, 1978
- ANTARES 100 kJ CO<sub>2</sub> LASER UNDER CONSTRUCTION NOW
- ANTARES PROTOTYPE SUCCESS ASSURES ANTARES DESIGN POINT PERFORMANCE WILL BE MET
- BREAKEVEN WITH CO<sub>2</sub> LASER SCHEDULED FOR 1983
- SYSTEMS STUDIES INDICATE CO<sub>2</sub> LASER FAVORABLE CANDIDATE FOR COMMERCIAL POWER PRODUCTION